

M20x1,5
Kabelanschluss
gland metric
raccord de câbles

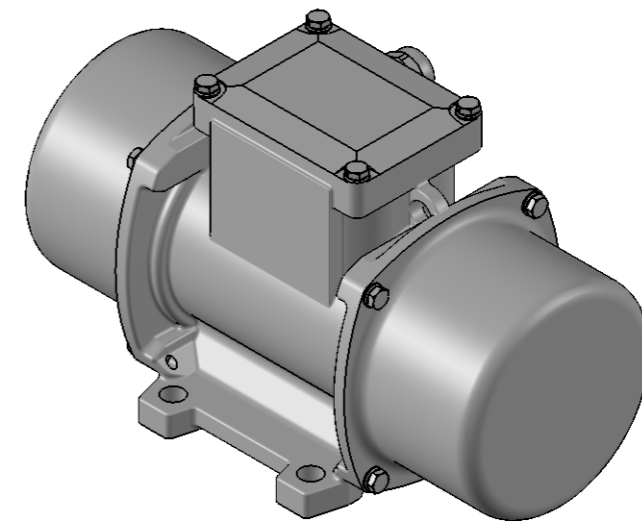
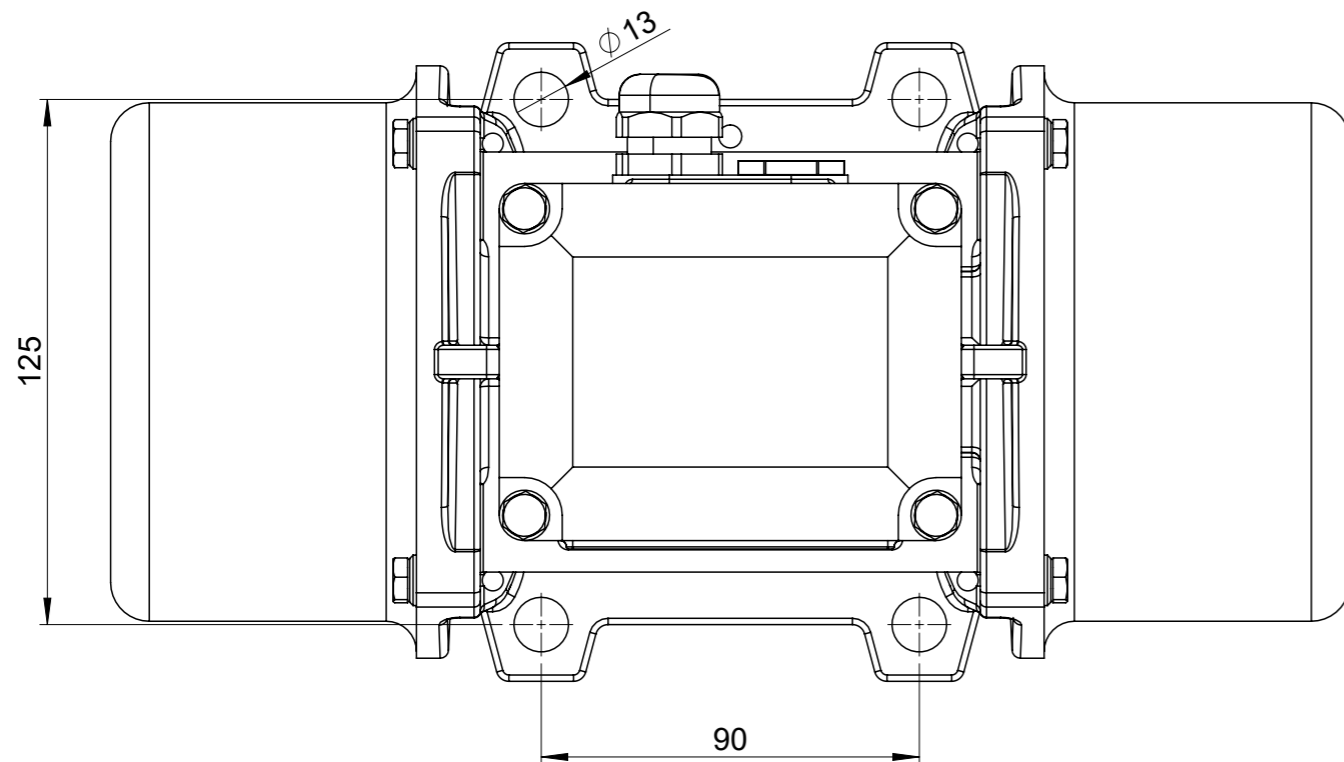
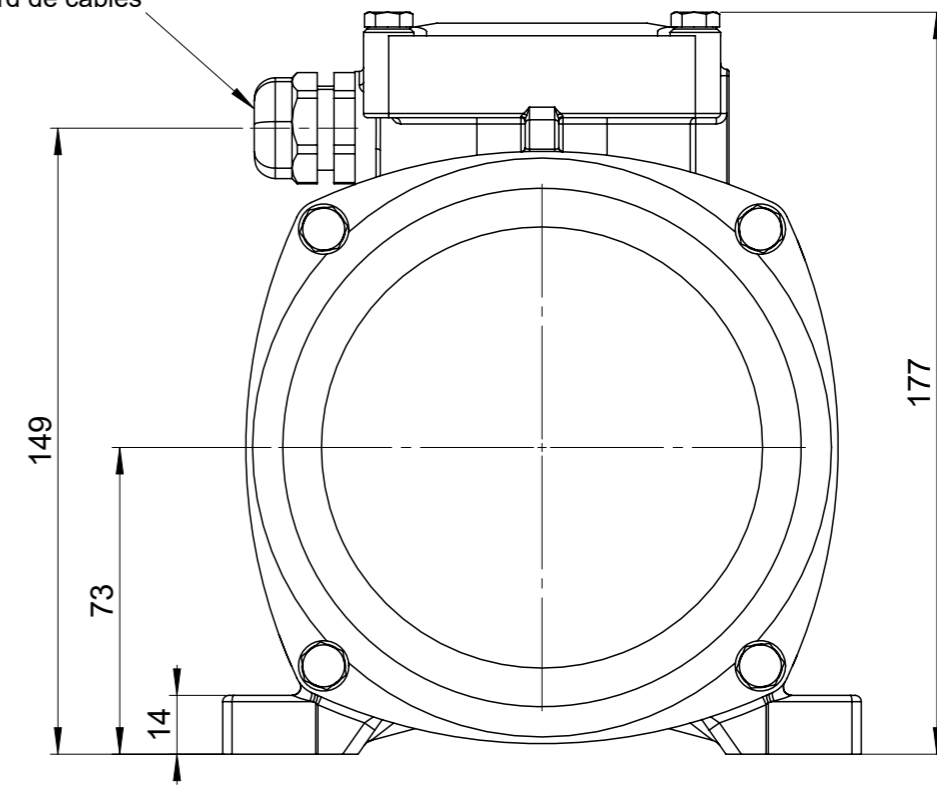

alle Schutzrechte vorbehalten
all rights reserved
tous droits réservés

Datum: / Date: / Date:
15.01.2019

Angebot Nr.: / Quotation no.: / Offre no.:

Bestell Nr.: / Part no.: / No d'article:
03022000

NES 25210

Elektro-Außenvibrator
Electric external vibrator
Vibrateur électrique externe

NetterVibration 
Fritz-Ullmann-Straße 9, 55252 Mainz-Kastel
Tel.: +49 6134 2901-0, www.NetterVibration.com